

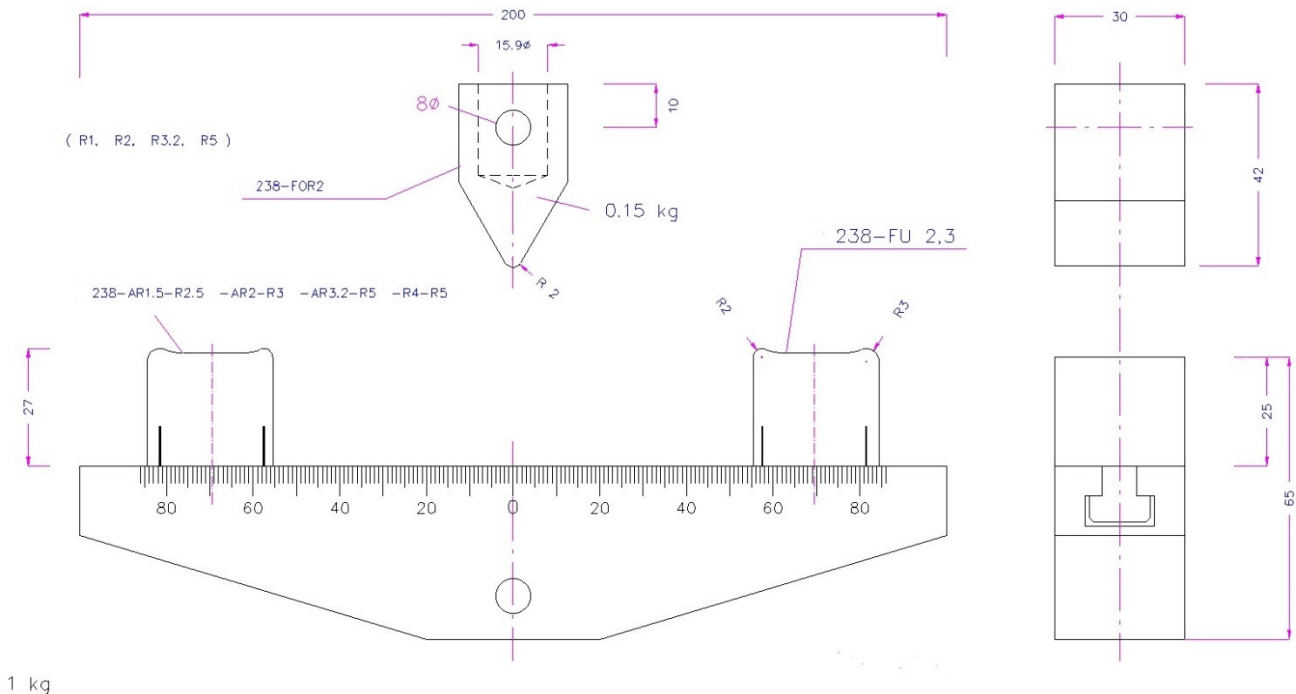

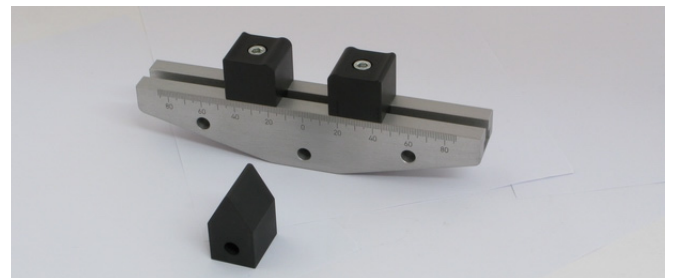



14 Collings Avenue, West Berlin, NJ 08091





**TA238 Flexural Fixture – 3 point bend & 4 point bend**

- 2.5 kN (550 lb) and 10 kN (2250 lb)
- Aluminum or Steel
- Base Width - 30 mm (1.4 in)
- Minimum Span - 4 mm (0.16 in)
- Base Options - 150 mm (6 in) and 300 mm (12 in)
- Roller (length made to customer specifications)  
1, 2, 3, 4, 5, 6, 6.35, 8, 10, 12, 12.7 mm
- Ideal for composites, plastics, sheeted metal, medical products, electronics and other materials



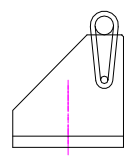
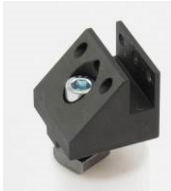

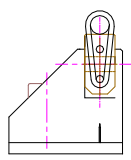
<p>TA238-AR1-R2</p>	<p>Simple 3 point bending system with Radius Lower radii 1,2,3,4,5,8,10 Upper radii 0.5,1,2,3,4,5,8,10</p>	
<p>TA238-CWXD4-4P</p>	<p>4 point bending jig with exchangeable rollers CX supports</p>	
<p>TA238-AX-4P-CWXD4</p>	<p>4 point bending jig with exchangeable rollers  lower AX supports Upper CX supports Width 30mm</p>	
<p>TA238-AXD6x100</p>	<p>Exchangeable roller with 6mm diameter width 100mm</p>	
<p>TA238-B300-B300-CWXD4</p>	<p>Bar 300mm Movable supports</p>	

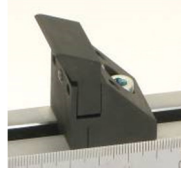

Number	Bars		
TA238-B200	lower bar Alu 200mm eloxated	1 x	
TA238-B200-St	lower bar steel 200mm cromed	1 x	
TA238-B300-St	lower bar steel 300mm cromed	1 x	
TA238-B350-St	lower bar steel 300mm cromed	1 x	
TA238-B400-St	lower bar steel 300mm cromed	1 x	
Number	Supports		
TA238-AR2-5	Support with 2 milled radius 2 and 5  r1-r2= available 1.5-2.5; 2-3; 2-5; 3.2-5; 4-5 hardened	2	
TA238-CR2	Supports with 1 milled Radius R2  R available: 0.5; 1; 1.5;2;2.5;3.2;5mm	2	
TA238-CrHx	Special Supports with 1 milled Radius  CR1H130 Radius 1mm Height 130mm	2	
TA238-AX	Support for exchangeable roller  Diameters 1 to 12.7mm	2	
TA238-AX		2	

TA238-CX	Support for exchangeable roller single V	2	
TA238-CN	Flat simple for glas	2	
TA238-CW	Supports for articulating carrier Fixable	2	
TA238-WX	movable carrier for exchangeable roller with pins and O-rings for fixing roller	3	
TA238-CWXD4	W support articulating complete with roller	2	
TA238-CWM	Flat moveable for glas	2	
TA238-WCN8	movable carrier exchangeable roller O-rings for fixing Roller 8mm diameter on a flat plane area	2	
TA238-CW2x120	Special movable fins fixable Radius R2 with width of 120mm (not in stock)	3	

14 Collings Avenue, West Berlin, NJ 08091

TA238-CWR1Z	Zero span moveable	2	
<b>Number</b>	<b>Roller</b>		
TA238-DX	Roller hardened Diameter X = : 1;2;2.5;3;3.175;4;4.5;5;6;6.35;8;9;10; 12;12.7mm	3	
TA238-AX x L	Roller with special length + 2 O-Rings + 2 extra pins to fix or magnets to fix  3x56;3x105;6x105;10x105	3	

14 Collings Avenue, West Berlin, NJ 08091

Number	Upper Anvils		
TA238-OR	Upper part anvil with milled Radius 1, 1.5; 2; 3; 4; 5; 12.5 mm	1	
TA238-oX	Upper part Anvil with milled V to carry different diameters oX2 keeps 1-3.2 mm Ø oX8 keeps 4-12.7 mm Ø	1	
TA238-OW	Upper part for articulating carrier	1	
TA238-OWX-D5	moveable anvil fixable with exchangeable roller 5mm diameter complete	1	

14 Collings Avenue, West Berlin, NJ 08091

**Special Options**

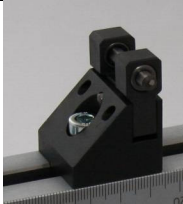
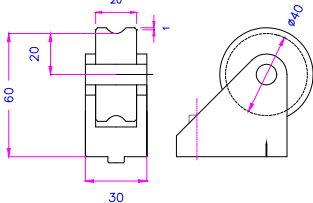
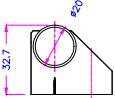
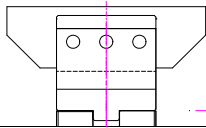
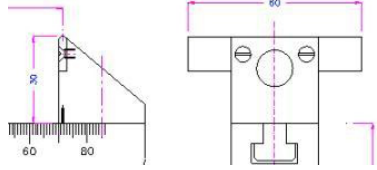
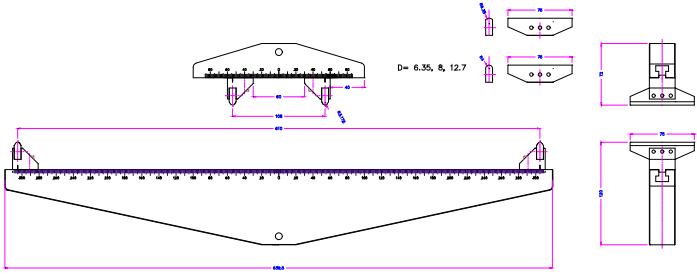
TA238-CWR5	Support moveable needle bearings	2x	
TA238-CLR40R5	Supports with roller and centerline R5	2	
TA238-CED10x100	Support with tube 10mm diameter width 100	2	
TA238-CWR2x50	Special Anvil milled Radius 3 length 50mm articulating carrier $\pm 3^\circ$	3	
TA238-CPR15x60	Support not moveable Radius 1.5mm width 60mm with anvil complete inclusive upper parts For a 4p bending system	4	
TA238-4P-B640-B200-CWR635-8-127x75	articulating carrier Radius 6.35		

14 Collings Avenue, West Berlin, NJ 08091

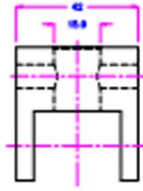

238-G-A159

238-G-Af

O...

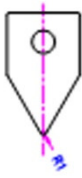

238-o1

238-o1.5

238-o5

238-o2

238-o3

238-o3.2

238-o5

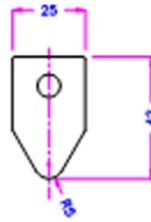

238-o5

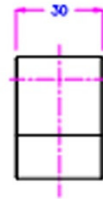

C...

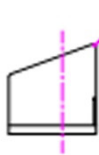

238-C05

238-C1

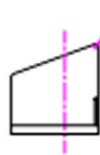

238-C2

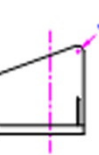

238-C3.2

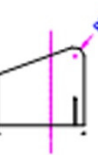

238-C5



238-C10

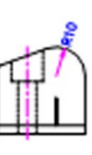

A...

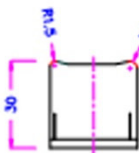

238-A15-25

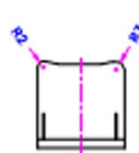

238-A2-3

238-A2-5

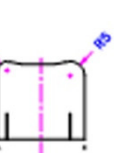
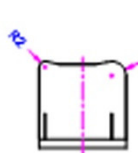

238-A32-5

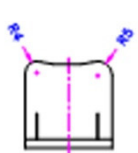

238-A4-5



14 Collings Avenue, West Berlin, NJ 08091

oX

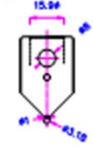

238-oX1-3

1-3, 20



238-oX4-12

4-12, 70

oWX

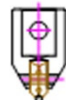

238-oWX

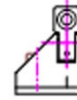

-CWLDS

CX



238-CX

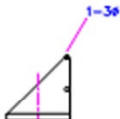

238-CXV1  
1-2

CWX



238-CW

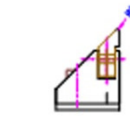

238-CWR1Z

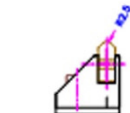

238-CWR2.5

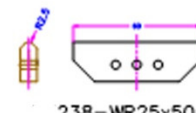

238-WR25x50

AX

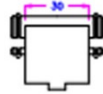
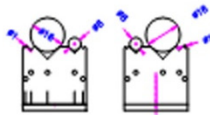

238-AX 1-16

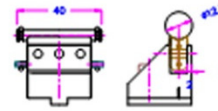

238-CWXD127



238-WX

D..

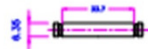

238-D635

D: 1, 2, 2.5, 3, 3.175, 4, 5, 6.35, 8, 10, 12.7



238-D10x100



14 Collings Avenue, West Berlin, NJ 08091

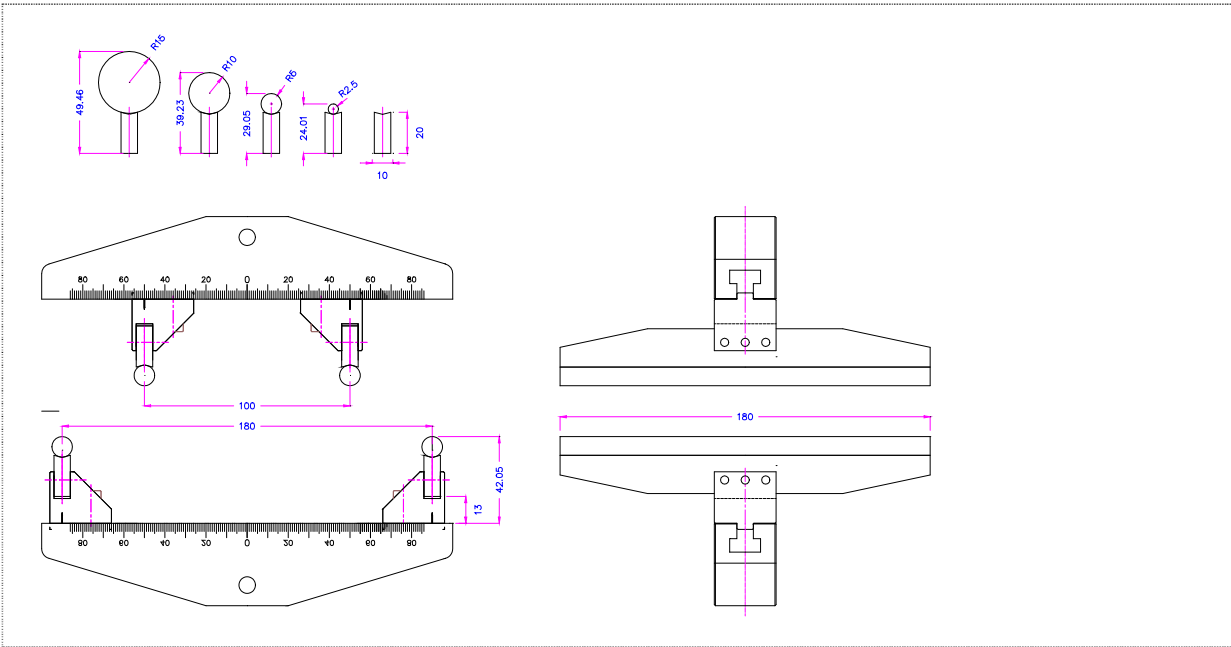

TA238-4P-CWXDx180

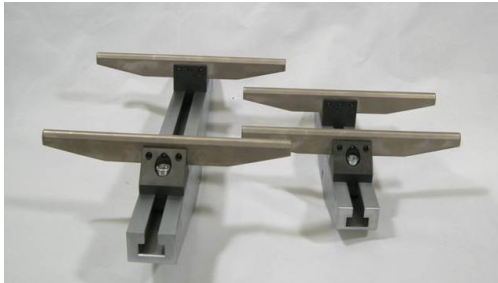

TA238-B300-4P-CWR5x170

14 Collings Avenue, West Berlin, NJ 08091



TA238-4P-CWXD8-iTH1-AfDP10s iTH1  
For chamber with extensometer

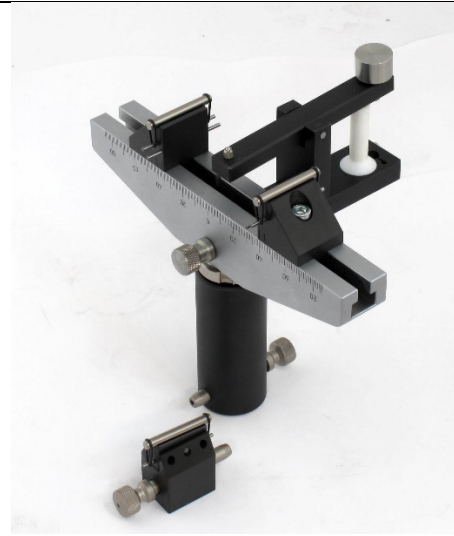

TA238-CWXD4-iTH2  
holder for external Extensometer



TA238-4P-CWXD15x180



TA238-CR01 Radius 0.1mm



TA238-CWXD4 iTH1  
holder for internal Extensometer - 8mm